

# JLX320-04103-PN 使用说明书

## (IPS 全视角)

### 目 录

序号	内 容 标 题	页 码
1	概述	2
2	特点	2
3	外形及接口引脚功能	3~4
4	基本原理	4
5	技术参数	4~5
6	时序特性	5~6
7	指令功能及硬件接口与编程案例	7~末页

## 1. 概述

晶联讯电子专注于液晶屏及液晶模块的研发、制造。所生产 JLX320-04103-PN 型液晶模块由于使用方便、显示清晰，广泛应用于各种人机交流面板。

JLX320-04103-PN 可以显示 IPS 全视角 320 列\*240 行点阵彩色图片，或显示 20 个/行\*15 行 16\*16 点阵的汉字，或显示 20 个/行\*30 行 8\*16 点阵的英文、数字、符号，或显示 40 个/行\*30 行 8\*8 点阵的英文、数字、符号。

本产品可选择带中文字库 IC 与不带中文字库 IC 两种。

## 2. JLX320-04103-PN 彩色图像型点阵液晶模块的特性

2.1 IPS 全视角，结构轻、薄、带背光、带铁框。

2.2 IC 采用 ST7789V, 功能强大，稳定性好

2.3 显示内容：

● 320\*240 点阵彩色图片；

● 可选用 32\*32 点阵或其他点阵的图片来自编汉字，按照 32\*32 点阵汉字来计算可显示 10 个字/行\*7 行。

● 可选用 16\*16 点阵或其他点阵的图片来自编汉字，按照 16\*16 点阵汉字来计算可显示 20 个字/行\*15 行。

2.4 指令功能强：例如可以用指令控制显示内容顺时针旋转 90°、逆时针旋转 90° 或倒立竖放。

2.5 接口简单方便。

2.6 工作温度宽： $-20^{\circ}\text{C} \sim +70^{\circ}\text{C}$ ；

2.7 工作温度宽： $-30^{\circ}\text{C} \sim +80^{\circ}\text{C}$ ；

2.8 TFT 模块是易碎的玻璃盒，请小心使用，轻拿轻放

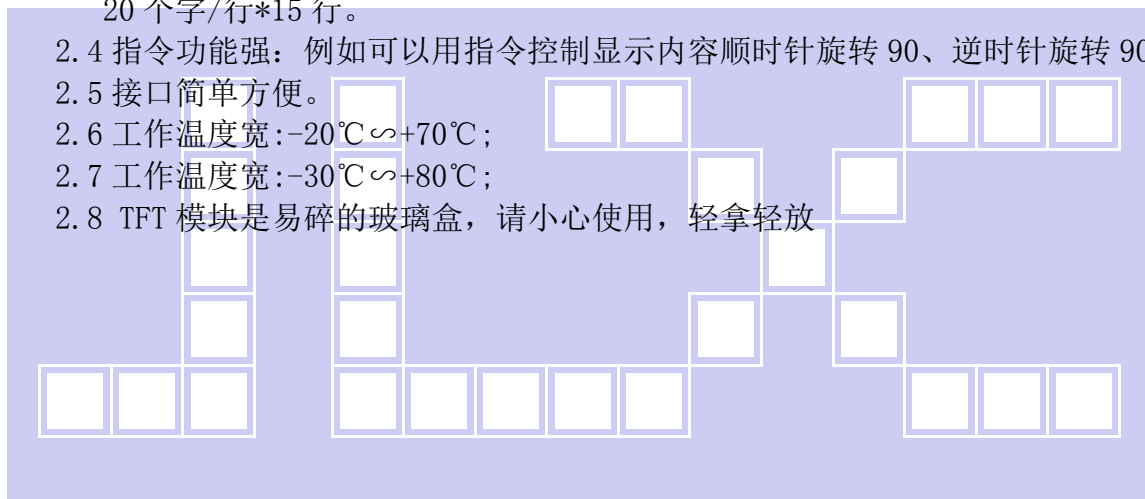

### 3. 外形尺寸及接口引脚功能



图 1. 外形尺寸

## 模块的接口引脚功能

表 1: 模块的接口引脚功能

引线号	符号	名称	功能
1	NC	NC	空
2	NC	NC	空
3	NC	NC	空
4	NC	NC	空
5	LEDA	背光电源	背光电源正极, 3.3V
6	VSS	接地	0V
7	VDD	电路电源	3.3V
8	A0 (RS)	寄存器选择信号	H: 数据寄存器 0: 指令寄存器 (IC 资料上所写为 "A0")
9	RST	复位	低电平复位, 复位完成后, 回到高电平, 液晶模块开始工作
10	CS	片选	低电平片选
11-18	D7-D0	I/O	数据总线 DB7-DB0
19	RD	读	读功能
20	WR	写	写功能

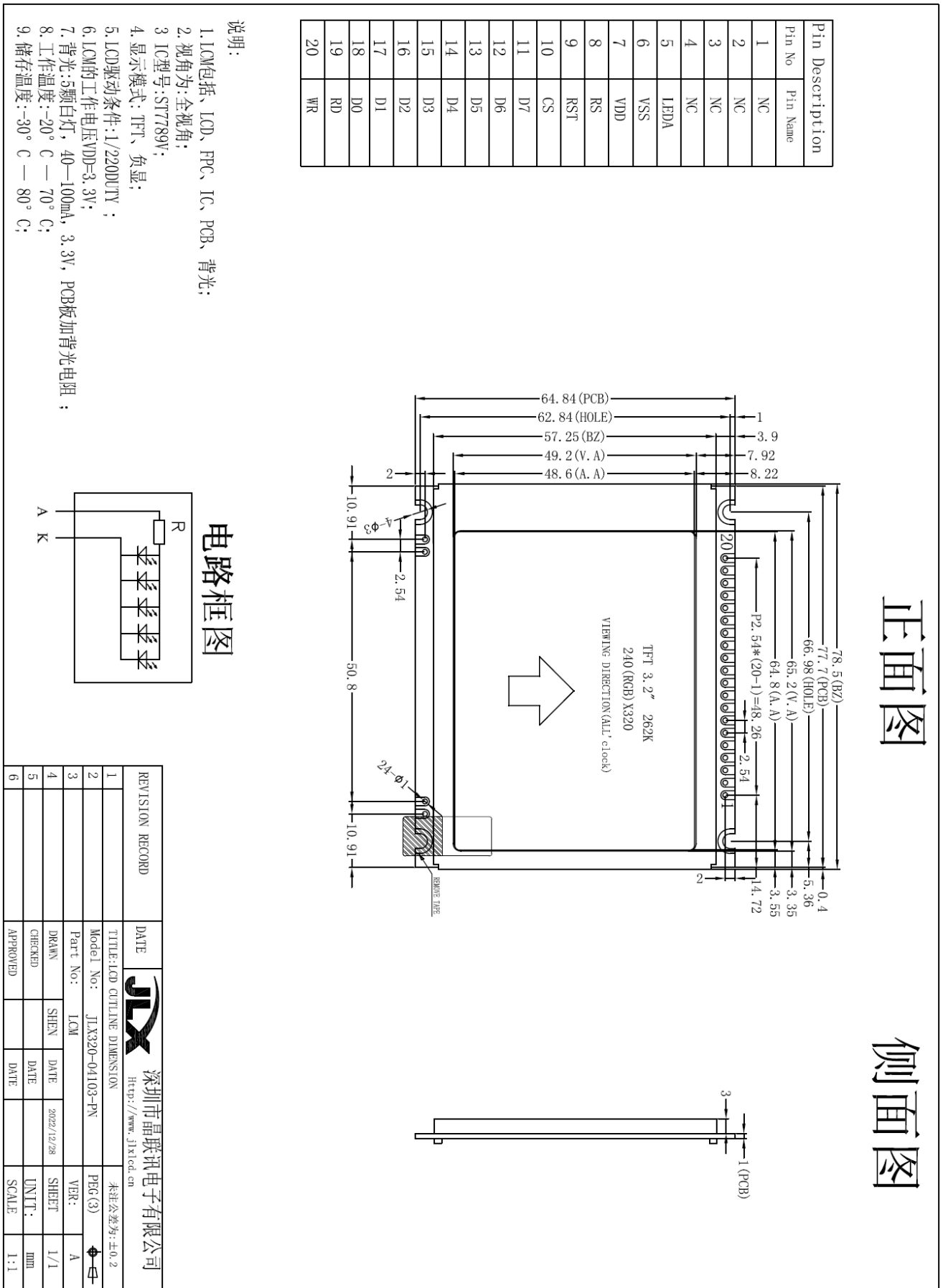
## 4. 基本原理

### 4.1 液晶屏 (LCD)

在 LCD 上排列着  $320 \times 240$  点阵, 320 个列信号与驱动 IC 相连, 240 个行信号也与驱动 IC 相连, IC 邦定在 LCD 玻璃上 (这种加工工艺叫 COG)。

### 4.3 背光参数

该型号液晶模块带 LED 背光源。它的性能参数如下:

工作温度:  $-20 \sim +70^{\circ}\text{C}$ ;

存储温度:  $-30 \sim +80^{\circ}\text{C}$ ;

背光板是白色。

正常工作电流为:  $50 \sim 100\text{mA}$  (LED 灯数共 5 颗, 每颗灯是  $10 \sim 20\text{mA}$ )

工作电压: 同 VDD 电压 (LED 灯本身的电压是 3.0V, 但是在 PCB 上已加了限流电阻, 所以可以同 VDD 电压);

## 5. 技术参数

### 5.1 最大极限参数 (超过极限参数则会损坏液晶模块)

名称	符号	标准值			单位
		最小	典型	最大	
电路电源	VDD	-0.3	3.3	3.6	V
工作温度		-20	+25	+70	$^{\circ}\text{C}$
储存温度		-30	+25	+80	$^{\circ}\text{C}$

表 2: 最大极限参数

## 5.2 直流 (DC) 参数

名称	符号	测试条件	标准值			单位
			最小	典型值	最大	
工作电压	VDD		2.8	3.3	3.6	V
背光工作电压	VLED		2.9	3.0	3.1	V
背光工作电流	ILED	VLED=3.0V, 共 5 颗 LED 灯并联	50	75	100	mA

表 3: 直流 (DC) 参数

## 6. 读写时序特性



图 2. 8080 时序图

### 6.1 时序要求 (AC 参数):

表 4.

项目	符号	测试条件	极限值			单位
			MIN	TYPE	MAX	
地址保持时间	A0	T <sub>AHt</sub>	10	—	—	ns
地址建立时间		T <sub>ASt</sub>	0	—	—	
芯片选择“高”脉冲宽度	CS	T <sub>CHW</sub>	0			
芯片选择建立时间(写)		T <sub>Cs</sub>	15			
芯片选择建立时间(读)		T <sub>RCS</sub>	45			
芯片选择保持时间	WR	T <sub>CSh</sub>	10			
写周期		T <sub>WC</sub>	66			
控制脉冲“高”持续时间		T <sub>WRH</sub>	15			
控制脉冲“低”持续时间		T <sub>WRl</sub>	15			

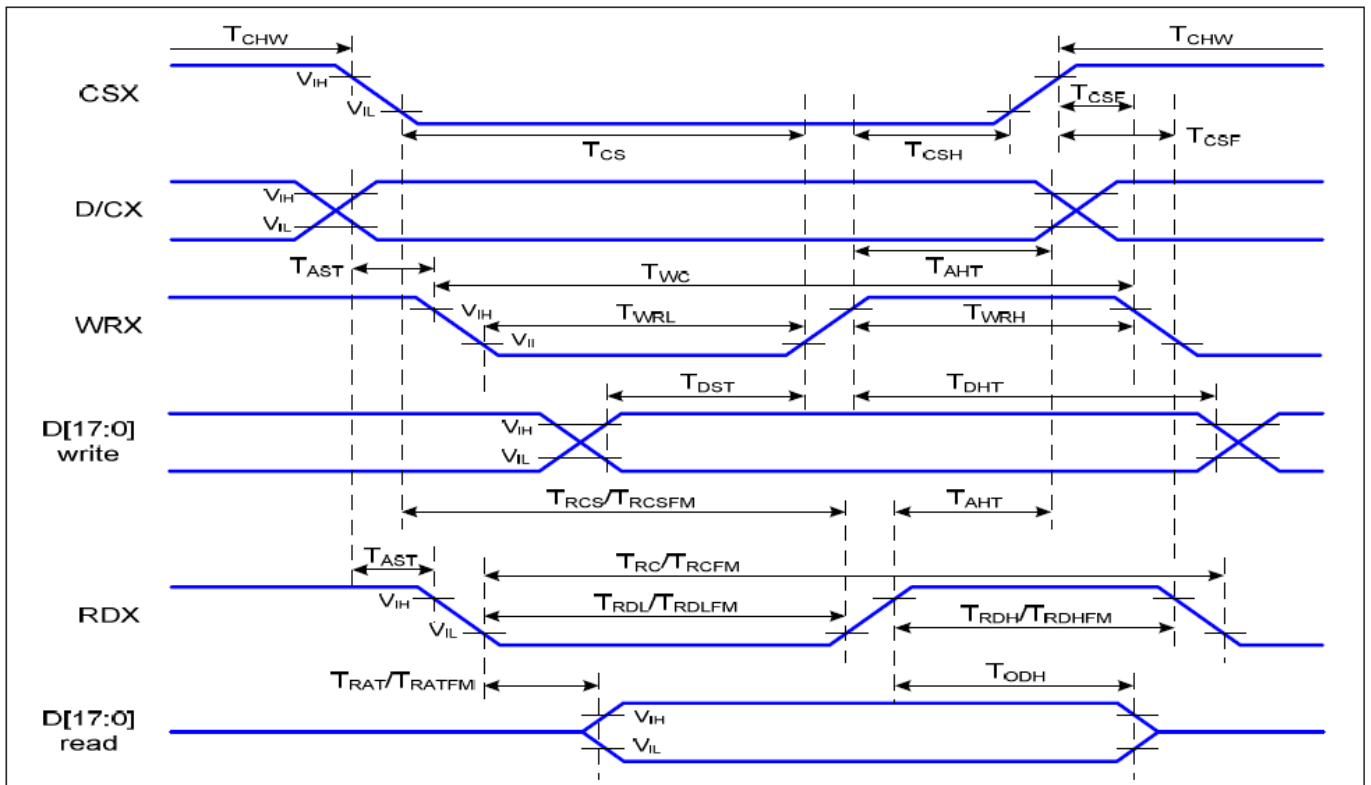
芯片选择保持时间	RD	T <sub>CSH</sub>	10		
读周期		T <sub>RC</sub>	160		
控制脉冲“高”持续时间		T <sub>RDH</sub>	90		
控制脉冲“低”持续时间		T <sub>RDL</sub>	45		
数据建立时间	D7-D0	T <sub>DST</sub>	10		
数据保持时间		T <sub>DHT</sub>	10		
读取时间		T <sub>RAT</sub>		40	
输出禁用时间		T <sub>ODH</sub>	20	80	

VDD=3.3V Ta=25°C

### 6.2 电源启动后复位的时序要求 (RESET CONDITION AFTER POWER UP):



图 3: 电源启动后复位的时序

表 5: 电源启动后复位的时序要求

VDD=3.3V, Ta = 25°C

项目	符号	测试条件	极限值			单位
			MIN	TYPE	MAX	
复位时间	t <sub>R</sub>		200	--	--	ms
复位保持低电平的时间	t <sub>RW</sub>	引脚: RES	200	--	--	ms

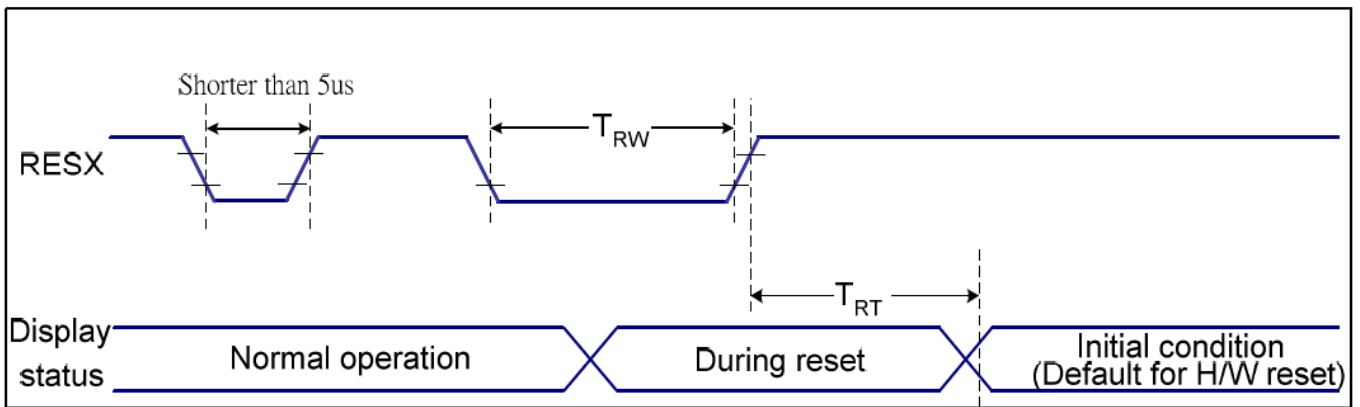
## 7. 指令功能:

### 7.1 指令表

Instruction	D/CX	WRX	RDX	D17-8	D7	D6	D5	D4	D3	D2	D1	D0	Hex	Function
NOP	0	↑	1	-	0	0	0	0	0	0	0	0	(00h)	No operation
SWRESET	0	↑	1	-	0	0	0	0	0	0	0	1	(01h)	Software reset
RDDID	0	↑	1	-	0	0	0	0	0	1	0	0	(04h)	Read display ID
	1	1	↑	-	-	-	-	-	-	-	-	-		Dummy read
	1	1	↑	-	ID17	ID16	ID15	ID14	ID13	ID12	ID11	ID10		ID1 read
	1	1	↑	-	ID27	ID26	ID25	ID24	ID23	ID22	ID21	ID20		ID2 read
	1	1	↑	-	ID37	ID36	ID35	ID34	ID33	ID32	ID31	ID30		ID3 read
RDDST	0	↑	1	-	0	0	0	0	1	0	0	1	(09h)	Read display status
	1	1	↑	-	-	-	-	-	-	-	-	-		Dummy read
	1	1	↑	-	BSTON	MY	MX	MV	ML	RGB	MH	ST24		-
	1	1	↑	-	ST23	IFPF2	IFPF1	IFPF0	IDMON	PTLON	SLOUT	NORON		-
	1	1	↑	-	ST15	ST14	INVON	ST12	ST11	DISON	TEON	GCS2		-
	1	1	↑	-	GCS1	GCS0	TEM	ST4	ST3	ST2	ST1	ST0		-
RDDPM	0	↑	1	-	0	0	0	0	1	0	1	0	(0Ah)	Read display power
	1	1	↑	-	-	-	-	-	-	-	-	-		Dummy read
	1	1	↑	-	BSTON	IDMON	PTLON	SLPOUT	NORON	DISON	0	0		
RDMADCTL	0	↑	1	-	0	0	0	0	1	0	1	1	(0Bh)	Read display
	1	1	↑	-	-	-	-	-	-	-	-	-		Dummy read
	1	1	↑	-	MY	MX	MV	ML	RGB	MH	0	0		-
RDCOLMOD	0	↑	1	-	0	0	0	0	1	1	0	0	(0Ch)	Read display pixel
	1	1	↑	-	-	-	-	-	-	-	-	-		Dummy read
	1	1	↑	-	0	D6	D5	D4	0	D2	D1	D0		-
RDDIM	0	↑	1	-	0	0	0	0	1	1	0	1	(0Dh)	Read display image
	1	1	↑	-	-	-	-	-	-	-	-	-		Dummy read
	1	1	↑	-	VSSON	0	INVON	0	0	GC2	GC1	GC0		-
RDDSM	0	↑	1	-	0	0	0	0	1	1	1	0	(0Eh)	Read display signal
	1	1	↑	-	-	-	-	-	-	-	-	-		Dummy read



Instruction	D/CX	WRX	RDX	D17-8	D7	D6	D5	D4	D3	D2	D1	D0	Hex	Function
	1	1	↑	-	TEON	TEM	0	0	0	0	0	0		-
RDDSDR	0	↑	1	-	0	0	0	0	1	1	1	1	(0Fh)	Read display self-diagnostic result
	1	1	↑	-	-	-	-	-	-	-	-	-		Dummy read
	1	1	↑	-	D7	D6	0	0	0	0	0	0		-
SLPIN	0	↑	1	-	0	0	0	1	0	0	0	0	(10h)	Sleep in
SLPOUT	0	↑	1	-	0	0	0	1	0	0	0	1	(11h)	Sleep out
PTLON	0	↑	1	-	0	0	0	1	0	0	1	0	(12h)	Partial mode on
NORON	0	↑	1	-	0	0	0	1	0	0	1	1	(13h)	Partial off (Normal)
INVOFF	0	↑	1	-	0	0	1	0	0	0	0	0	(20h)	Display inversion off
INVON	0	↑	1	-	0	0	1	0	0	0	0	1	(21h)	Display inversion on
GAMSET	0	↑	1	-	0	0	1	0	0	0	0	1	(26h)	Display inversion on
	1	↑	1	-	0	0	0	0	GC3	GC2	GC1	GC0		on
DISPOFF	0	↑	1	-	0	0	1	0	1	0	0	0	(28h)	Display off
DISPON	0	↑	1	-	0	0	1	0	1	0	0	1	(29h)	Display on
CASET	0	↑	1	-	0	0	1	0	1	0	1	0	(2Ah)	Column address set
	1	↑	1	-	XS15	XS14	XS13	XS12	XS11	XS10	XS9	XS8		X address start:
	1	↑	1		XS7	XS6	XS5	XS4	XS3	XS2	XS1	XS0		$0 \leq XS \leq X$
	1	↑	1		XE15	XE14	XE13	XE12	XE11	XE10	XE9	XE8		X address start:
1	↑	1		XE7	XE6	XE5	XE4	XE3	XE2	XE1	XE0		$S \leq XE \leq X$	
RASET	0	↑	1	-	0	0	1	0	1	0	1	1	(2Bh)	Row address set
	1	↑	1	-	YS15	YS14	YS13	YS12	YS11	YS10	YS9	YS8		Y address start:
	1	↑	1		YS7	YS6	YS5	YS4	YS3	YS2	YS1	YS0		$0 \leq YS \leq Y$
	1	↑	1		YE15	YE14	YE13	YE12	YE11	YE10	YE9	YE8		Y address start:
1	↑	1		YE7	YE6	YE5	YE4	YE3	YE2	YE1	YE0		$S \leq YE \leq Y$	
RAMWR	0	↑	1	-	0	0	1	0	1	1	0	0	(2Ch)	Memory write
	1	↑	1	D1[17:8]	D1[7]	D1[6]	D1[5]	D1[4]	D1[3]	D1[2]	D1[1]	D1[0]		Write data
	1	↑	1	Dx[17:8]	Dx[7]	Dx[6]	Dx[5]	Dx[4]	Dx[3]	Dx[2]	Dx[1]	Dx[0]		
1	↑	1	Dn[17:8]	Dn[7]	Dn[6]	Dn[5]	Dn[4]	Dn[3]	Dn[2]	Dn[1]	Dn[0]			
RAMRD	0	↑	1	-	0	0	1	0	1	1	1	0	(2Eh)	Memory read



Instruction	D/CX	WRX	RDX	D17-8	D7	D6	D5	D4	D3	D2	D1	D0	Hex	Function
	1	1	↑	-	-	-	-	-	-	-	-	-		Dummy read
	1	1	↑	D1[17:8]	D1[7]	D1[6]	D1[5]	D1[4]	D1[3]	D1[2]	D1[1]	D1[0]		Read data
	1	1	↑	Dx[17:8]	Dx[7]	Dx[6]	Dx[5]	Dx[4]	Dx[3]	Dx[2]	Dx[1]	Dx[0]		
	1	1	↑	Dn[17:8]	Dn[7]	Dn[6]	Dn[5]	Dn[4]	Dn[3]	Dn[2]	Dn[1]	Dn[0]		
PTLAR	0	↑	1	-	0	0	1	1	0	0	0	0	(30h)	Partial start/end address set
	1	↑	1	-	PSL15	PSL14	PSL13	PSL12	PSL11	PSL10	PSL9	PSL8		Partial start address: (0, 1, 2, ...P)
	1	↑	1	-	PSL7	PSL6	PSL5	PSL4	PSL3	PSL2	PSL1	PSL0		
	1	↑	1	-	PEL15	PEL14	PEL13	PEL12	PEL11	PEL10	PEL9	PEL8		Partial end address (0, 1, 2, 3, ...P)
VSCRDEF	0	↑	1	-	0	0	1	1	0	0	1	1	(33h)	Vertical scrolling definition
	1	↑	1	-	TFA15	TFA14	TFA13	TFA12	TFA11	TFA10	TFA9	TFA8		
	1	↑	1	-	TFA7	TFA6	TFA5	TFA4	TFA3	TFA2	TFA1	TFA0		
	1	↑	1	-	VSA15	VSA14	VSA13	VSA12	VSA11	VSA10	VSA9	VSA8		
	1	↑	1	-	VSA7	VSA6	VSA5	VSA4	VSA3	VSA2	VSA1	VSA0		
	1	↑	1	-	BFA15	BFA14	BFA13	BFA12	BFA11	BFA10	BFA9	BFA8		
	1	↑	1	-	BFA7	BFA6	BFA5	BFA4	BFA3	BFA2	BFA1	BFA0		
TEOFF	0	↑	1	-	0	0	1	1	0	1	0	0	(34h)	Tearing effect line off
TEON	0	↑	1	-	0	0	1	1	0	1	0	1	(35h)	Tearing effect line on
	1	↑	1	-	-	-	-	-	-	-	-	TEM		
MADCTL	0	↑	1	-	0	0	1	1	0	1	1	0	(36h)	Memory data access control
	1	↑	1	-	MY	MX	MV	ML	RGB	0	0	0		-
VSCRSAADD	0	↑	1	-	0	0	1	1	0	1	1	1	(37h)	Vertical scrolling start address
	1	↑	1	-	VSP15	VSP14	VSP13	VSP12	VSP11	VSP10	VSP9	VSP8		
	1	↑	1	-	VSP7	VSP6	VSP5	VSP4	VSP3	VSP2	VSP1	VSP0		
IDMOFF	0	↑	1	-	0	0	1	1	1	0	0	0	(38h)	Idle mode off
IDMON	0	↑	1	-	0	0	1	1	1	0	0	1	(39h)	Idle mode on

Instruction	D/CX	WRX	RDX	D17-8	D7	D6	D5	D4	D3	D2	D1	D0	Hex	Function
COLMOD	0	↑	1	-	0	0	1	1	1	0	1	0	(3Ah)	Interface pixel format
	1	↑	1	-	0	D6	D5	D4	0	D2	D1	D0		Interface format
RAMWRC	0	↑	1	-	0	0	1	1	1	1	0	0	(3Ch)	Memory write continue
	1	↑	1	D1[17:8]	D1[7]	D1[6]	D1[5]	D1[4]	D1[3]	D1[2]	D1[1]	D1[0]		Write data
	1	↑	1	Dx[17:8]	Dx[7]	Dx[6]	Dx[5]	Dx[4]	Dx[3]	Dx[2]	Dx[1]	Dx[0]		
	1	↑	1	Dn[17:8]	Dn[7]	Dn[6]	Dn[5]	Dn[4]	Dn[3]	Dn[2]	Dn[1]	Dn[0]		
RAMRDC	0	↑	1	-	0	0	1	1	1	1	1	0	(3Eh)	Memory read continue
	1	1	↑	-	-	-	-	-	-	-	-	-		Dummy Read
	1	1	↑	D1[17:8]	D1[7]	D1[6]	D1[5]	D1[4]	D1[3]	D1[2]	D1[1]	D1[0]		
	1	1	↑	Dx[17:8]	Dx[7]	Dx[6]	Dx[5]	Dx[4]	Dx[3]	Dx[2]	Dx[1]	Dx[0]		
	1	1	↑	Dn[17:8]	Dn[7]	Dn[6]	Dn[5]	Dn[4]	Dn[3]	Dn[2]	Dn[1]	Dn[0]		
TESCAN	0	↑	1	-	0	1	0	0	0	1	0	0	(44h)	Set tear scanline
	1	↑	1	-	N15	N14	N13	N12	N11	N10	N9	N8		
	1	↑	1	-	N7	N6	N5	N4	N3	N2	N1	N0		
RDTESCAN	0	↑	1	-	0	1	0	0	0	1	0	1	(45h)	Get scanline
	1	1	↑	-	-	-	-	-	-	-	-	-		Dummy Read
	1	1	↑	-	-	-	-	-	-	-	N9	N8		
	1	1	↑	-	N7	N6	N5	N4	N3	N2	N1	N0		
WRDISBV	0	↑	1	-	0	1	0	1	0	0	0	1	(51h)	Write display brightness
	1	↑	1	-	DBV7	DBV6	DBV5	DBV4	DBV3	DBV2	DBV1	DBV0		
RDDISBV	0	↑	1	-	0	1	0	1	0	0	1	0	(52h)	Read display brightness value
	1	1	↑	-	-	-	-	-	-	-	-	-		Dummy read
	1	1	↑	-	DBV7	DBV6	DBV5	DBV4	DBV3	DBV2	DBV1	DBV0		
WRCTRLD	0	↑	1	-	0	1	0	1	0	0	1	1	(53h)	Write CTRL display
	1	↑	1	-	0	0	BCTRL	0	DD	BL	0	0		
RDCTRLD	0	↑	1	-	0	1	0	1	0	1	0	0	(54h)	Read CTRL value display
	1	1	↑	-	-	-	-	-	-	-	-	-		Dummy read
	1	1	↑	-	0	0	BCTRL	0	DD	BL	0	0		

Instruction	D/CX	WRX	RDX	D17-8	D7	D6	D5	D4	D3	D2	D1	D0	Hex	Function
WRCACE	0	↑	1	-	0	1	0	1	0	1	0	1	(55h)	Write content adaptive brightness control and Color enhancemnet
	1	↑	1	-	CECTRL	0	CE1	CE0	0	0	C1	C0		
RDCABC	0	↑	1	-	0	1	0	1	0	1	1	0	(56h)	Read content adaptive brightness control
	1	1	↑	-	-	-	-	-	-	-	-	-		Dummy read
	1	1	↑	-	0	CECTRL	0	0	0	0	C1	C0		
WRCABCMB	0	↑	1	-	0	1	0	1	1	1	1	0	(5Eh)	Write CABC minimum brightness
	1	↑	1	-	CMB7	CMB6	CMB5	CMB4	CMB3	CMB2	CMB1	CMB0		
RDCABCMB	0	↑	1	-	0	1	0	1	1	1	1	1	(5Fh)	Read CABC minimum brightness
	1	1	↑	-	-	-	-	-	-	-	-	-		Dummy read
	1	1	↑	-	CMB7	CMB6	CMB5	CMB4	CMB3	CMB2	CMB1	CMB0		
RDABCSDR	0	↑	1	-	0	1	1	0	1	0	0	0	(68h)	Read Automatic Brightness Control Self-Diagnostic Result
	1	1	↑	-	-	-	-	-	-	-	-	-		Dummy read
	1	1	↑	-	D7	D6	0	0	0	0	0	0		-
RDID1	0	↑	1	-	1	1	0	1	1	0	1	0	(DAh)	Read ID1
	1	1	↑	-	-	-	-	-	-	-	-	-		Dummy read
	1	1	↑	-	ID17	ID16	ID15	ID14	ID13	ID12	ID11	ID10		Read parameter
RDID2	0	↑	1	-	1	1	0	1	1	0	1	1	(DBh)	Read ID2
	1	1	↑	-	-	-	-	-	-	-	-	-		Dummy read
	1	1	↑	-	ID27	ID26	ID25	ID24	ID23	ID22	ID21	ID20		Read parameter
RDID3	0	↑	1	-	1	1	0	1	1	1	0	0	(DCh)	Read ID3

Instruction	D/CX	WRX	RDX	D17-8	D7	D6	D5	D4	D3	D2	D1	D0	Hex	Function
	1	1	↑	-	-	-	-	-	-	-	-	-		Dummy read
	1	1	↑		ID37	ID36	ID35	ID34	ID33	ID32	ID31	ID30		Read parameter

## 7.2 初始化方法

用户所编的显示程序, 开始必须进行初始化, 否则模块无法正常显示, 过程请参考程序

### 点亮液晶模块的步骤

**硬件准备:**  
开发板 (或专门设计的主板)、单片机、电源、连接线、仿真器或程序下载器 (又名烧录器)

**正确地接线**  
根据说明书正确地与开发板连接, 连接的线包括: 液晶模块电源线、背光电源线、IO端口 (接口)  
IO端口包括: 并口时: CS、RESET、RW、E、RS、D0--D7, 串口时: CS、SCLK、SDA、RESET、RS

**编写软件**  
背光给合适的直流电可以点亮, 但液晶屏里面没有程序, 只给电不能让液晶屏显示 (我们通常说“点亮”), 程序须另外编写, 并烧录 (下载) 到单片机里液晶模块才能工作。

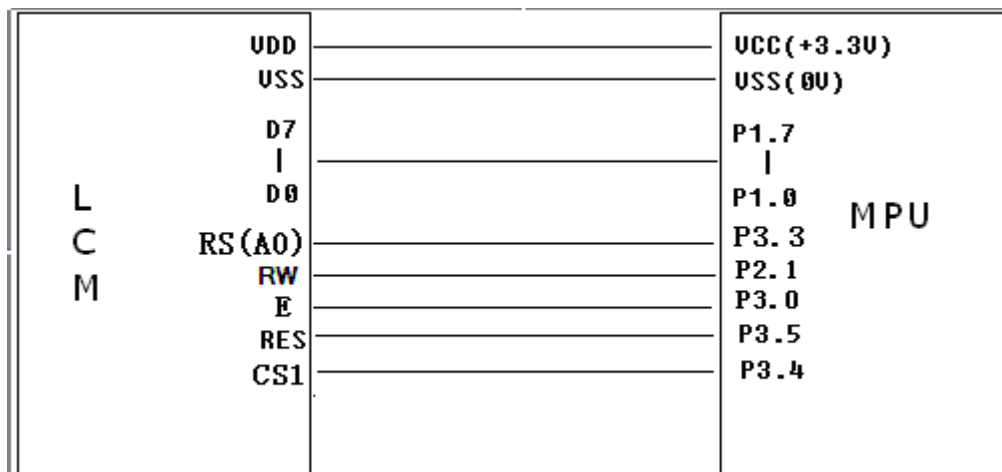

### 点亮液晶模块的编程步骤



#### 7.3 程序举例:

```

#include <reg51.h>
#include <chinese_code.h>
  
```

//液晶屏 IC 所需要的信号线的接口定义

```

sbit DC0=P3^3; //A0/RS
sbit WR0=P2^1; //RW
sbit RD0=P3^0; //E
sbit CS0=P3^4; //CS1
sbit reset=P3^5; //RES
sbit key=P2^0; //P2.0 口与 GND 之间接一个按键
  
```

```

void transfer_command(int com1)
{
  
```

```

    CS0 = 0;
    DCO = 0;
    RDO = 1;
    P1=com1;
    WRO = 0;
    WRO = 1;
    CS0 = 1;
}

```

```

void transfer_data(int data1)
{

```

```

    CS0 = 0;
    DCO = 1;
    RDO = 1;
    P1=data1;
    WRO = 0;
    WRO = 1;
    CS0 = 1;
}

```

//===传 16 位指令，16 位指令一起赋值

```

void transfer_command_16(uint com_16bit)
{

```

```

    transfer_command(com_16bit>>8);    //先传高 8 位
    transfer_command(com_16bit);       //再传低 8 位
}

```

//连写 2 个字节（即 16 位）数据到 LCD 模块

```

void transfer_data_16(uint data_16bit)
{

```

```

    transfer_data(data_16bit>>8);
    transfer_data(data_16bit);
}

```

//===发送 1 个字节的指令及 1 个字节的数

```

void Lcd_Write_Com_Data(uint com, uint val)
{

```

```

    transfer_command_16(com);    //先传指令
    transfer_data_16(val);      //再传数据
}

```

```

void delay(long i)
{

```

```

    int j,k;
    for(j=0;j<i;j++)

```

```

    for(k=0;k<110;k++);
}

```

```

void delay_us(long i)
{
    int j,k;
    for(j=0;j<i;j++)
        for(k=0;k<10;k++);
}

```

```

void Switch()
{
    // repeat:
    // if (key==1) goto repeat;
    // else
        delay(3000);
}

```

```

void lcd_initial()
{
    reset=0;
    delay(200);
    reset=1;
    delay(200);
    //***** Start Initial Sequence *****//
    //-----display and color format setting-----//
    transfer_command(0x36); //行扫描顺序及RGB, 列扫描顺序, 横放/竖放
    transfer_data(0x00);
    transfer_data(0x48);

    transfer_command(0xB6); //显示功能设置: 列/行 显示顺序
    transfer_data(0x0A);
    transfer_data(0x82); //改变 SOURCE 线的方向: 0xa2: 左到右, 0x82: 右到左

    transfer_command(0x3a); //256K 16bit/pixel
    transfer_data(0x05);
    //-----ST7789V Frame rate setting-----//
    transfer_command(0xb2);
    transfer_data(0x0c);
    transfer_data(0x0c);
    transfer_data(0x00);
    transfer_data(0x33);
    transfer_data(0x33);
    transfer_command(0xb7);
    transfer_data(0x35);
}

```



//-----ST7789V Power setting-----//

```
transfer_command(0xbb);
transfer_data(0x28);
transfer_command(0xc0);
transfer_data(0x2c);
transfer_command(0xc2);
transfer_data(0x01);
transfer_command(0xc3);
transfer_data(0x10);
transfer_command(0xc4);
transfer_data(0x20);
transfer_command(0xc6);
transfer_data(0x0f);
transfer_command(0xd0);
transfer_data(0xa4);
transfer_data(0xa1);
```

//-----ST7789V gamma setting-----//

```
transfer_command(0xe0);
transfer_data(0xd0);
transfer_data(0x00);
transfer_data(0x02);
transfer_data(0x07);
transfer_data(0x0a);
transfer_data(0x28);
transfer_data(0x32);
transfer_data(0x44);
transfer_data(0x42);
transfer_data(0x06);
transfer_data(0x0e);
transfer_data(0x12);
transfer_data(0x14);
transfer_data(0x17);
```

```
transfer_command(0xe1);
transfer_data(0xd0);
transfer_data(0x00);
transfer_data(0x02);
transfer_data(0x07);
transfer_data(0x0a);
transfer_data(0x28);
transfer_data(0x31);
transfer_data(0x54);
transfer_data(0x47);
transfer_data(0x0e);
transfer_data(0x1c);
transfer_data(0x17);
```

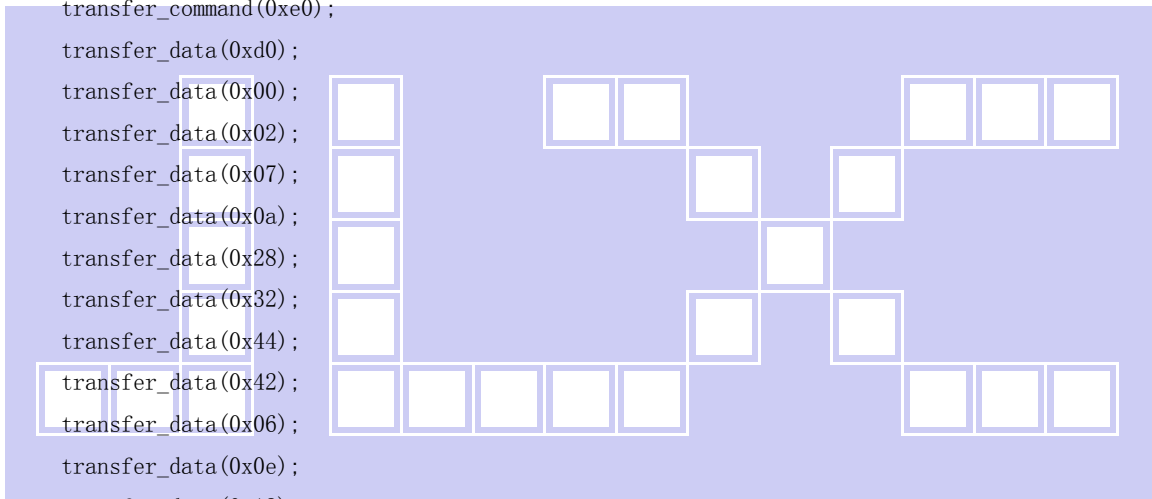



```

transfer_data(0x1b);
transfer_data(0x1e);

transfer_command(0x21); //这条指令很重要, 不加显示异常, 开负显
transfer_command(0x11); //退出睡眠
delay(200);
transfer_command(0x29); //打开显示
}
    
```

//定义窗口坐标: 开始坐标 (XS,YS)以及窗口大小 (x\_total,y\_total)

```
void lcd_address(int XS,int YS,int x_total,int y_total)
```

```

{
    int XE, YE;
    XE=XS+x_total-1;
    YE=YS+y_total-1;
    transfer_command(0x2a); // 设置 X 开始及结束的地址
    transfer_data_16(XS); // X 开始地址(16 位)
    transfer_data_16(XE); // X 结束地址(16 位)
    
```

```

    transfer_command(0x2b); // 设置 Y 开始及结束的地址
    transfer_data_16(YS); // Y 开始地址(16 位)
    transfer_data_16(YE); // Y 结束地址(16 位)

    transfer_command(0x2c); // 写数据开始
}
    
```

```
void mono_transfer_data_16(int mono_data,int font_color,int back_color)
```

```

{
    int i;
    for(i=0;i<8;i++)
    {
        if(mono_data&0x80)
        {
            transfer_data_16(font_color); //当数据是 1 时, 显示字体颜色
        }
        else
        {
            transfer_data_16(back_color); //当数据是 0 时, 显示底色
        }
        mono_data<<=1;
    }
}
    
```

//全屏显示一种颜色

```
void display_color(int color_data)
```



```

{
    int i, j;
    lcd_address(0, 0, 240, 320);
    for(i=0; i<240; i++)
    {
        for(j=0; j<320; j++)
        {
            transfer_data_16(color_data);
        }
    }
}

```

```

void display_white(void)

```

```

{
    int i, j;
    transfer_command(0x2c);
    for(i=0; i<240; i++)
    {
        for(j=0; j<320; j++)
        {
            transfer_data_16(0xffff);
        }
    }
}

```

```

void display_black(void)

```

```

{
    int i, j, k;
    transfer_command(0x2c); // 写数据开始
    for(i=0; i<240; i++)
    {
        transfer_data_16(0xffff);
    }
    for(i=0; i<318; i++)
    {
        for(k=0; k<1; k++)
        {
            transfer_data_16(0xffff);
        }
        for(j=0; j<238; j++)
        {
            transfer_data_16(0x0000);
        }
        for(k=0; k<1; k++)
        {

```

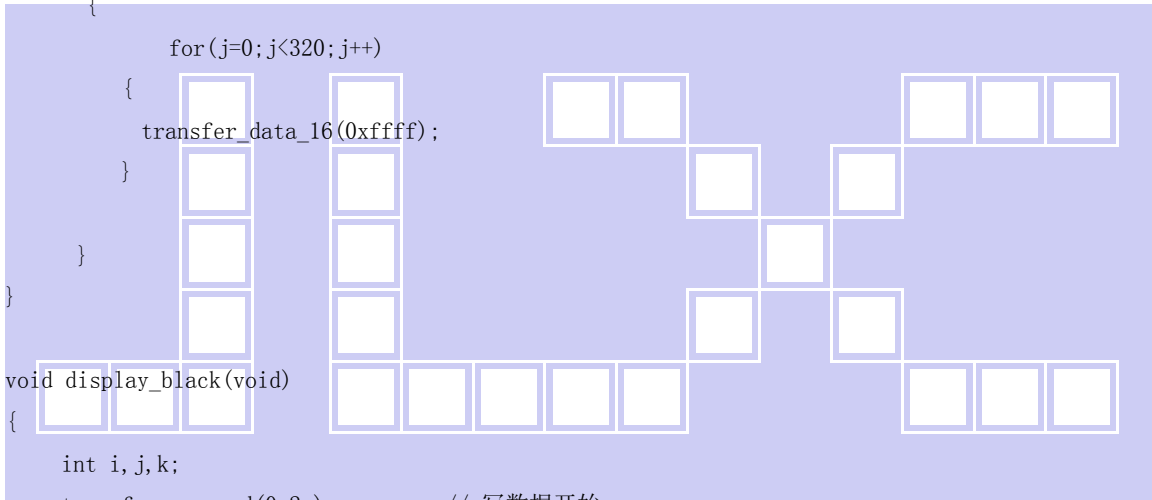

```

        transfer_data_16(0xffff);
    }
}
for(i=0;i<320;i++)
{
    transfer_data_16(0xffff);
}
}

```

//显示 8x16 点阵的字符串

```

void disp_string_8x16(int x,int y,char *text,int font_color,int back_color)
{
    int i=0,j,k;
    while(text[i]>0x00)
    {
        if((text[i]>=0x20)&&(text[i]<=0x7e))
        {

```

```

            j=text[i]-0x20;
            lcd_address(x,y,8,16);
            for(k=0;k<16;k++)
            {
                mono_transfer_data_16(ascii_table_8x16[j*16+k],font_color,back_color);
                //?a??ascii_table_8x16[]"?a??èy×é?ú"ASCII_TABLE_5X8_8X16_horizontal.h"à?
            }
            x+=8;
            i++;
        }
        else
            i++;
    }
}

```



```

void display_string_16x16(int x,int y,uchar *text,int font_color,int back_color)
{
    uchar i,j,k;
    uint address;
    j = 0;
    while(text[j] != '\0') //'\0' 字符串结束标志
    {
        i = 0;
        address = 1;
        while(Chinese_horizontal_text_16x16[i] > 0x7e) // >0x7f 即说明不是 ASCII 码字符
        {
            if(Chinese_horizontal_text_16x16[i] == text[j])
            {
                if(Chinese_horizontal_text_16x16[i + 1] == text[j + 1])

```

```

        {
            address = i * 16;
            break;
        }
    }
    i += 2;
}
if(y > 240)
{
    y=0;
    x+=16;
}

```

```

if(address != 1)// 显示汉字

```

```

{
    lcd_address(x, y, 16, 16);
    for(i=0;i<2;i++)
    {
        for(k = 0; k <16; k++)
        {
            mono_transfer_data_16(Chinese_horizontal_code_16x16[address], font_color, back_color);
            address++;
        }
        j+=2;
    }
    else //显示空白字符
    {
        lcd_address(x, y, 16, 16);
        for(i = 0; i <2; i++)
        {
            for(k = 0; k < 16; k++)
            {
                mono_transfer_data_16(0x00, font_color, back_color);
            }
        }
        j+=2;
    }
    x=x+16;
}
}

```



```

//显示 32x32 点阵的单色的图像

```

```

void disp_32x32(int x,int y,char *dp,int font_color,int back_color)
{

```

```

int i, j;
lcd_address(x, y, 32, 32);
for(i=0;i<32;i++)
{
    for(j=0;j<4;j++)
    {
        mono_transfer_data_16(*dp, font_color, back_color);
        dp++;
    }
}
}

```

//显示一幅彩图

```
void display_image(int x,int y,uchar *dp)
```

```

{
    uchar i, j, k=0;
    lcd_address(x, y, 120, 160);
    for(i=0;i<120;i++)
    {
        for(j=0;j<160;j++)
        {
            transfer_data(*dp); //传一个像素的图片数据的高位
            dp++;
            transfer_data(*dp); //传一个像素的图片数据的低位
            dp++;
        }
    }
}

```

```
void main(void)
```

```

{
    lcd_initial();
    while(1)
    {
        display_color(blue);
        disp_32x32(40+32*0, 8, jing_32x32, white, blue);
        disp_32x32(40+32*1, 8, lian_32x32, white, blue);
        disp_32x32(40+32*2, 8, xun_32x32, white, blue);
        disp_32x32(40+32*3, 8, dian_32x32, white, blue);
        disp_32x32(40+32*4, 8, zi_32x32, white, blue);

        display_string_16x16(24, 56, "深圳市晶联讯电子有限公司", white, blue);

        disp_string_8x16(72, 88, "JLX320-04103", white, blue);
        Switch();
    }
}

```



```
display_image(0, 0, pic1);
display_image(120, 0, pic1);
display_image(0, 160, pic1);
display_image(120, 160, pic1);
Switch();
```

```
display_color(0xf800);
Switch();
display_color(0x07e0);
Switch();
display_color(0x001f);
Switch();
display_black();
Switch();
display_color(0xffff);
Switch();
```

```
}
```

